



Device Circuit Breakers

Selective power distribution



RSPSupply - 1-888-532-2706 - <https://www.RSPSupply.com>
See the product details here

System availability at the highest level

Phoenix Contact device circuit breakers provide ideal protection against overload currents and short-circuit currents for all applications. Select a suitable device circuit breaker for your application from this diverse range of products.

Universal and easy to bridge

With the PTCB device circuit breakers, you can protect your applications with minimal installation space.

- Product details and advantages
Page 14/15
- Product data and application
Page 27–29

Modular expansion and remote control

Adapt your application to suit your individual requirements with the CB E device circuit breakers.

- Product details and advantages
Page 16/17
- Product data and application
Page 30

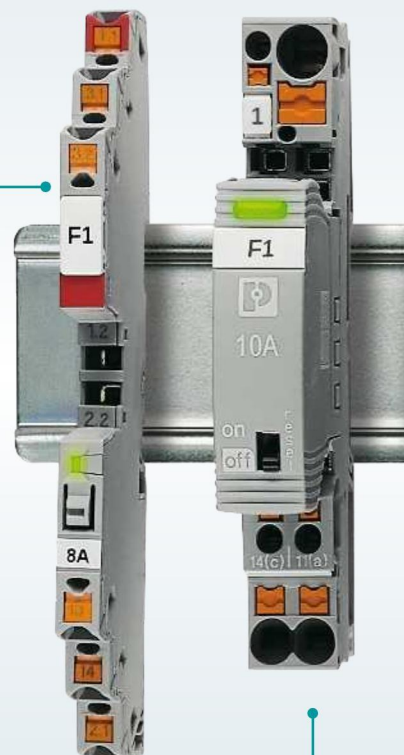

Highly functional and space saving

Protect up to eight channels with an overall width of just 41 mm with the CBM.

- Product details and advantages
Page 8/9
- Product data and application
Page 22

Compact and adjustable

The CBMC device circuit breakers are operated intuitively and a version is also available with IO-Link interface.

- Product details and advantages
Page 10–13
- Product data and application
Page 23–25

Suitable for a wide range of applications

When you opt for the CB TM device circuit breakers, three tripping characteristics are available for different applications.

- Product details and advantages
Page 18/19
- Product data and application
Page 32/33

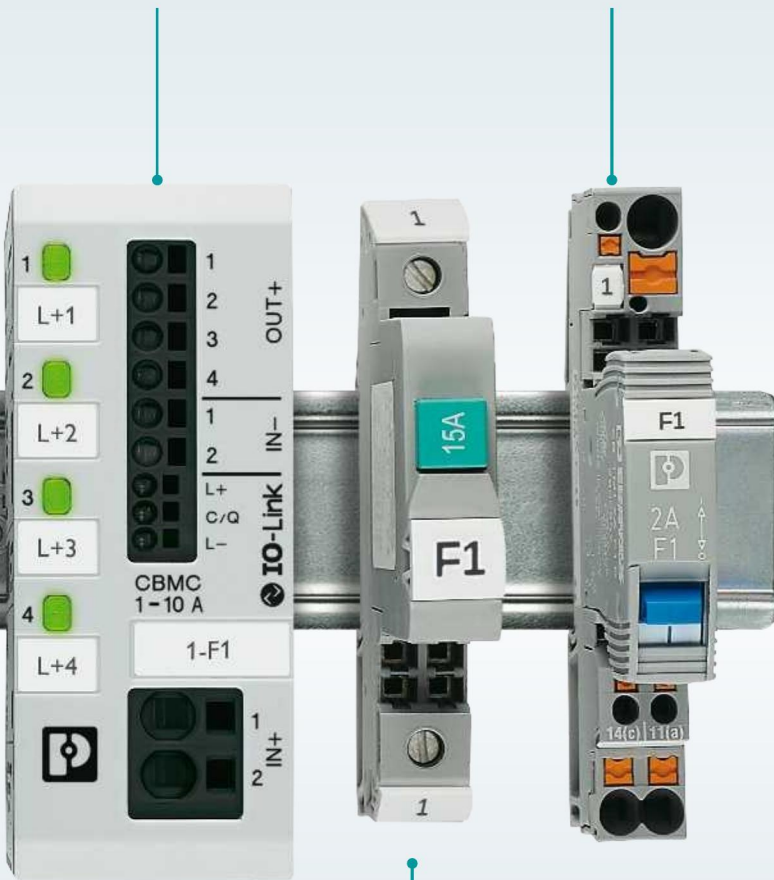

Tried-and-tested and straightforward

UT 6-TMC – can be reset and featuring a generous marking area.

- Product details and advantages
Page 20/21
- Product data and application
Page 31

Find out more with the web code

For more information, use the web codes provided in this brochure. Simply enter # and the four-digit number in the search field on our website.

i Web code: #1234 (example)

Or use the direct link:

phoenixcontact.net/webcode/#1234

Contents

Fundamentals of device circuit breakers	4
Fundamentals of electronic circuit breakers	6
Multi-channel electronic circuit breakers	8
Compact multi-channel electronic circuit breakers	10
Narrow electronic circuit breakers	14
Single-channel electronic circuit breakers	16
Thermomagnetic device circuit breakers	18
Product and order overview with application example	22
Power supplies and device circuit breakers	34

Fundamentals of device circuit breakers

Selective device protection with the widest range of tripping mechanisms provides maximum safety for every consumer. This means that only the areas that are actually affected by an overload or short circuit current are shut down. Different demands exist, depending on the area of application and task. You will find the right solution for every demand in the Phoenix Contact product range.

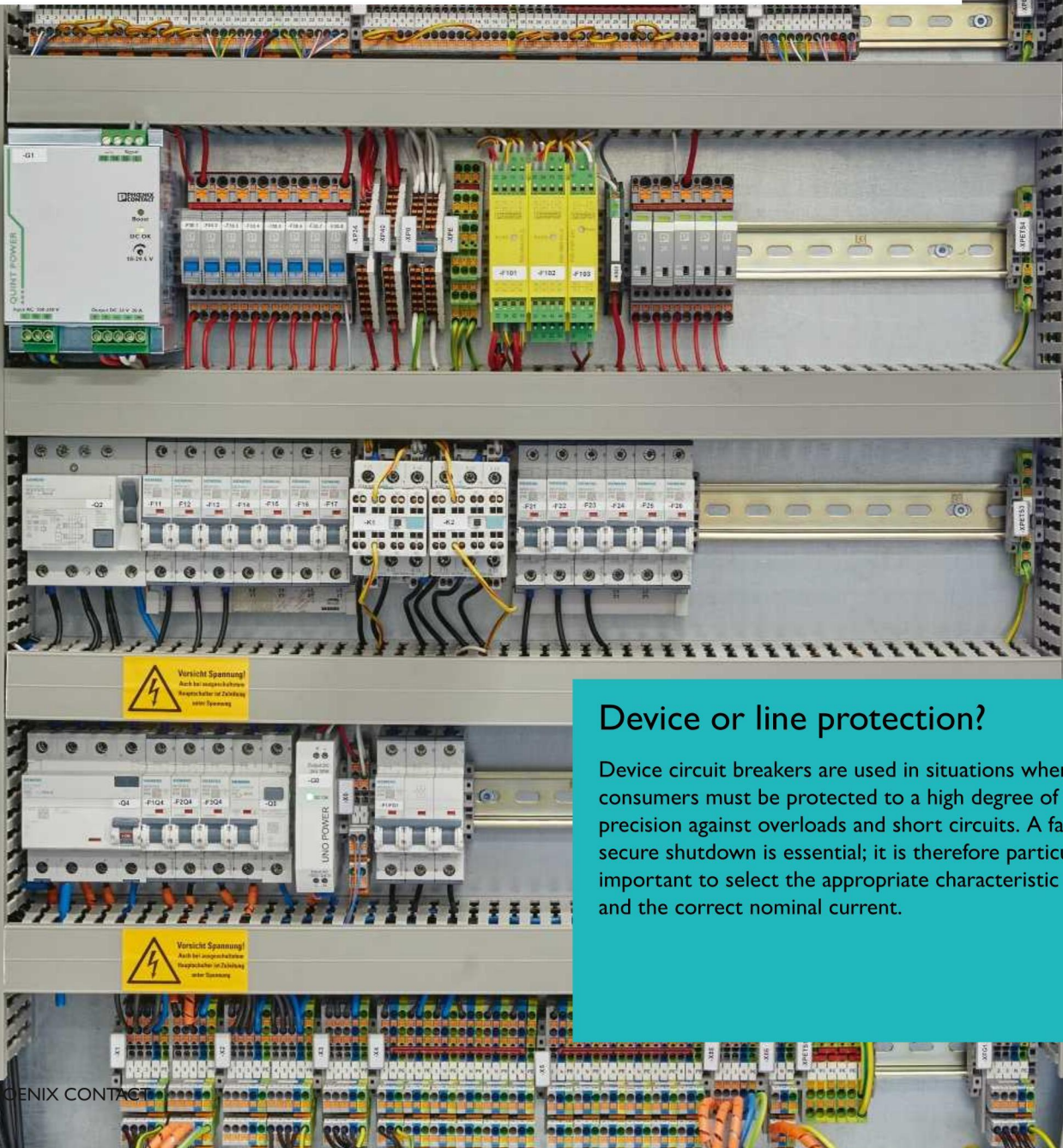

Device or line protection?

Device circuit breakers are used in situations where consumers must be protected to a high degree of precision against overloads and short circuits. A fast and secure shutdown is essential; it is therefore particularly important to select the appropriate characteristic curve and the correct nominal current.

Options, technologies, and versions

Why device circuit breakers?

Overload currents and short-circuit currents are usually unexpected. They cause malfunctions and interrupt the operation of a system. Undesirable production downtimes and repair costs are often the result. You can minimize damage by protecting individual devices or device groups separately with device circuit breakers. This provides end devices with optimum protection against damage or destruction. System parts that are not in the affected circuit continue to operate without interruption, assuming the overall process allows it.

Overload currents:

Overload currents occur when end devices unexpectedly require a higher current than the intended rated current. Such situations can arise, for example, when a drive is blocked.

Temporary starting currents for machines are also overload currents. Although in principle their occurrence can be determined by calculation, they can vary depending upon the machine load when starting.

Take these conditions into account when selecting suitable fuses or circuit breakers for such circuits. Safe shutdown should occur within a range of a few seconds up to a few minutes.

Short-circuit currents:

Short circuits can arise between damaged operating voltage-carrying conductors. Typical protective devices for interrupting short-circuit currents include fuses and miniature circuit breakers with various tripping mechanisms.

Short-circuit currents should be safely interrupted within milliseconds.

Various technologies offering different forms of protection

Phoenix Contact provides thermal, thermomagnetic and electronic circuit breakers.

The thermal circuit breakers protect via a bimetallic strip that leads to tripping when heated. However, this takes between 300 ms and several minutes. In the event of overloads, this period of time is more than sufficient.

The magnetic part of the thermomagnetic circuit breaker provides protection in the event of a short circuit. If the current suddenly increases, shutdown occurs within a few milliseconds.

Electronic circuit breakers reliably protect against both overloads and short-circuit currents, and also offer many advantages.

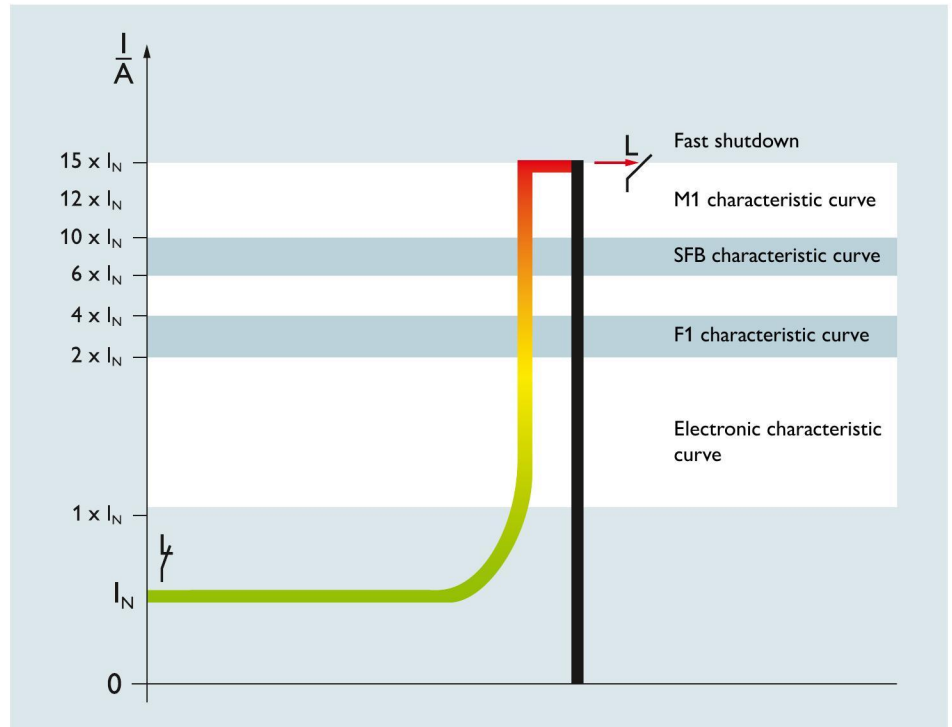

Tripping behavior of various device circuit breakers

Current and voltage are measured and monitored permanently. Errors are detected far more precisely and quickly. Currents are assessed and interrupted sooner or later, depending on their intensity. An electronic circuit breaker will trip at a significantly lower current than an electromechanical circuit breaker. This allows the power supply output to be utilized far more efficiently. Reserves no longer need to be sized as generously.

Selecting the right device circuit breakers

The requirements for optimum device protection vary, depending on the area of application and task. Device circuit breakers therefore feature a wide range of technologies: electronic, thermal, and thermomagnetic.

The differences are in the tripping technology and the shutdown behavior. Characteristic curves clearly illustrate the shutdown characteristic of the various device circuit breakers. Device circuit breakers are selected based on the nominal voltage, nominal current, and, if required, the starting current of an end device. The expected error situation – short circuit or overload – then determines the appropriate shutdown behavior.

Fundamentals of electronic circuit breakers

Electronic circuit breakers feature high functionality and take up little space. They offer many advantages, such as adjustability, signaling, evaluation, and controllability. They can be installed flexibly in the widest variety of applications, and therefore provide reliable protection for the devices in your application.

Selective protection

Phoenix Contact electronic circuit breakers can provide protection with and without current limitation. Other consumers therefore remain unaffected. The integrated sensor continuously measures the current applied and switches off selectively in the event of an overload current or short circuit.

Intelligent, individual, and intuitive

The advantages of electronic circuit breakers

Intelligent software is the core of an electronic circuit breaker. The software differentiates between operating currents and harmful currents and rapidly transmits commands to the electronic system. Faults must be detected and shutdown as quickly as possible, whereas inrush currents or normal operating currents should not be shut down. The switching operation is performed via the power transistor.

Steps to error detection:

- Measurement: to monitor the ongoing situation, all electrical variables are measured continuously.
- Analysis: the measured values are analyzed in order to determine a course of action.
- Classification: the currents are evaluated and classified.
- Protect and switch: depending on the class of the analyzed current, the consumer is started or shut down. The rest of the system remains in operation and unaffected.
- Signaling: the operating states of all circuits are transmitted continuously to the system operator. If an event occurs, it is detected immediately and reported.

The correct setting

To be able to determine the correct nominal current value for a device circuit breaker, you should know the consumer(s). However, the actual current often deviates from the manufacturer's information. In a consumer group, these errors accumulate, which means that the total current deviates even more from the calculated value.

Here, adjustable device circuit breakers offer considerable advantages, and therefore a high degree of flexibility.

Firstly, the set value should not be much higher than the flowing current value. The necessary starting current of a consumer can, however, influence the necessary set value. In this case, set the lowest value at which smooth operation can be assured.

Adjustable circuit breakers:

The intelligent software in the electronic circuit breakers allows the nominal current to be set individually. This means you can maintain the highest level of flexibility throughout. It is not always possible to determine the correct current value right at the start of a project. Adjustability is therefore a useful function, because the final current value can then be determined during commissioning. You can provide optimal protection for every consumer, tailored precisely to the application.

This adjustability also provides you with the option of covering several applications with one device. This not only saves you inventory costs, it also makes selecting the correct circuit breaker much easier.

Circuit breakers with fixed values:

For many, circuit breakers provide a high degree of safety if the current value is not adjustable. In this case, nothing can be adjusted in the system, and all of the settings carried out by the installer remain unchanged. The current values must, however, be determined during configuration. If a value is unsuitable, the entire circuit breaker or protective plug must be replaced.

Keeping currents properly under control

Current limitation:

The extent of current limitation is described by a factor, normally between 1.25 and 2.0. This value is not exceeded, even in the event of an error. For the power supply, even a hard short circuit therefore has the same effect as a slight overload, the current is significantly lower than without current limitation and the supply voltage to the system remains unaffected.

Without current limitation:

With a circuit breaker without current limitation, the supply voltage can drop out in the event of an error, which means that all the connected devices would fail as well. This means that, in the event of an error, the installed electronics and the integrated firmware must react quickly and intelligently. Although short circuit must be detected and shut down quickly, it must still be possible to reliably start a capacitive load.

Calculating the cable length

In order that the protective device shuts down safely in the event of a short circuit or overload current, the maximum usable cable length should be calculated to be on the safe side. The following data is necessary:

- R_{max} Maximum total resistance
- U Nominal voltage
- I_{CB} Rated current CB
- xI Tripping factor according to current characteristic curve/multiple of the nominal current
- R_{Lmax} Maximum cable resistance
- R_{CB1A} Internal resistance CB 1 A
- L_{max} Maximum cable length
- A Conductor cross section

- ρ Specific cable resistance Rho, (Cu 0.01786)

Values for sample calculation:

- $U = 24 \text{ V DC}$
- $xI = 15$ (from the M1 characteristic curve)
- $I_{CB} = 1 \text{ A}$
- $R_{CB1A} = 1.1$
- $\rho = 0.01786$ (copper)
- $A = 1.5 \text{ mm}^2$ (assumed)

1. Total circuit resistance:

$$R_{max} = \frac{U}{I_{CB} \cdot xI} = \frac{24 \text{ V}}{1 \text{ A} \cdot 15} = 1,6 \Omega$$

2. Maximum cable resistance:

$$R_{Lmax} = R_{max} - R_{CB1A} = 1,6 \Omega - 1,1 \Omega = 0,5 \Omega$$

3. Maximum cable length:

$$L_{max} = \frac{R_{Lmax} \cdot A}{\rho} = \frac{0,5 \Omega \cdot 1,5 \text{ mm}^2}{0,01786 \frac{\Omega \cdot \text{mm}^2}{\text{m}}} = 42 \text{ m}$$

Calculation in three steps

Multi-channel electronic circuit breakers

Configuring a device circuit breaker has never been easier. Using the integrated nominal current wizard, selecting the appropriate current for the connected consumer is incredibly easy. This makes configuration fast, convenient, and simple.

i Web code: #1646



Your advantages

- ✓ Easy to configure, thanks to the nominal current wizard
- ✓ Active current limitation to improve the capacity of the upstream power supply
- ✓ Adjustable in increments per channel: from 0.5 A to 10 A

Push-in Technology 
Designed by PHOENIX CONTACT

Product advantages at a glance



Easy configuration

The nominal current wizard makes configuration of the CBM exceptionally easy. It enables optimal adjustment of the consumer currents. Simply turn the potentiometers, until the optimum current has been found. The LED indicates when the ideal setting has been found. It could not be easier to configure the system protection.

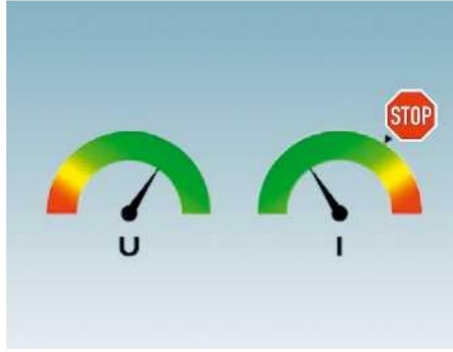

Active current limitation

The active current limitation restricts short circuit and overload currents to a value that is 1.5 to 2 times the nominal current. This protects the power supply against excessively high currents and prevents output voltage dips at the switched-mode power supply unit. In addition, longer cable paths between the power supply and consumer are possible without negatively impacting the shutdown behavior.

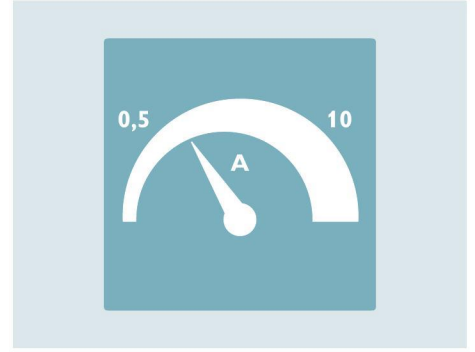

Adjustable in steps

The nominal current can be adjusted at the CBM in fine increments. The nominal current range is 0.5 to 10 A. This allows you to adjust the channels individually to the nominal currents of the connected end devices. You can make the settings individually for each channel. This means that one device can be used for an extremely wide range of consumers.

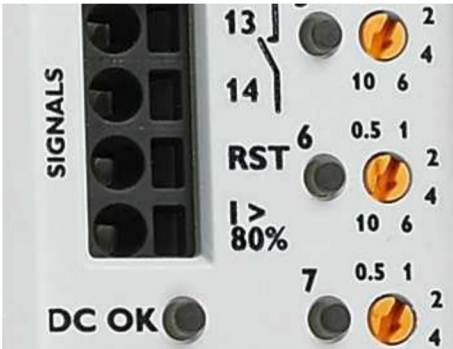

Analysis and signaling

The currents flowing are constantly monitored. The CBM not only features a potential-free signal contact to indicate capacity utilization, it also has an 80% output. You are alerted as soon as at least one channel is being heavily utilized. The channel that has been switched off can then be easily switched back on remotely via the Reset RST signal input.



Undervoltage/overvoltage

Differentiate between undervoltages and overvoltages in your system and therefore increase your system availability. The channels are shut down in the event of an error in the operating voltage and the system is switched to a defined state. The error is signaled directly via the remote indication contact. An LED also indicates the deviation directly on the device.



8 channels in an extremely narrow installation space

Save space in the control cabinet with the 8-channel CBM E8 device circuit breaker. Reliably protect eight channels against overload and short-circuit currents in just one device with an overall width of just 41 mm. Reduce inventory costs and also ensure outstanding flexibility in system planning.

Compact multi-channel electronic circuit breakers

The CBMC electronic circuit breaker is precisely tailored to your requirements: it combines a compact design with individual adjustability. This means that you can easily and flexibly adjust currents, save space, and reliably protect all applications with just one device.

i Web code: #1646



Your advantages

- ✓ Easy device replacement without re-planning, thanks to compact design and options for individual adjustment
- ✓ Circuits can be adjusted without any tools via a single LED pushbutton
- ✓ Can be ordered preconfigured – for device protection that meets the specific requirements of your system

Push-in Technology 
Designed by PHOENIX CONTACT

Product advantages at a glance



Compact overall width

Save space in the control cabinet with the CBMC, or convert existing systems with little effort. Thanks to the combination of compact overall width and individual adjustability, selecting the correct product is incredibly easy, and at the same time you save inventory costs, as only one device is required.



Tool-free configuration

One-button operation enables very easy adjustment of individual circuits. This allows you to adjust the channels of the device circuit breaker individually based on your needs and without any tools.

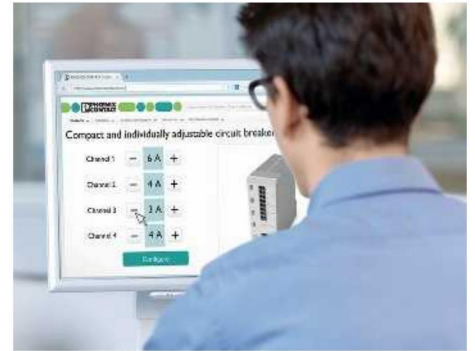

Can be ordered preconfigured

You can order your device circuit breakers preconfigured starting from a minimum quantity of one unit. You receive the device ready-made for your system. Thanks to this pre-configuration, you save valuable time during commissioning. You can choose whether you want the settings to remain adjustable or whether they should be fixed in order to provide protection against manipulation.



NEC Class 2 circuits

The 1-4 A version is approved in accordance with NEC Class 2. You can therefore easily configure energy-limited circuits with the CBMC. Instead of an NEC Class 2 power supply unit, simply use your powerful standard power supply unit. Benefit from quicker and easier installation and testing of your application.

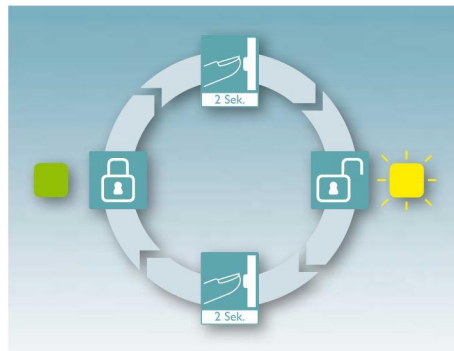

Electronic interlock

Thanks to an integrated electronic interlock, the CBMC device circuit breakers provide reliable protection against unauthorized changes to the configured current values. The circuits connected are therefore reliably protected.



Status indicator in traffic light colors

The multi-functional buttons are not only a means of programming the device circuit breaker, they also detect the operating state of the product and connected devices and indicate the status using traffic light colors.

Compact multi-channel electronic circuit breakers with IO-Link

IO-Link gives you the option of fully integrating the device circuit breakers into the process monitoring and control systems. This gives you the latest information on currents and capacity utilization at all times as well as an overview of all processes. Naturally, you also benefit from the features of the standard device with the CBMC IO-Link.

i Web code: #1646



Your advantages

- ✓ System transparency, thanks to comprehensive diagnostics capabilities
- ✓ Worldwide access to the device, thanks to integration into your IO-Link infrastructure
- ✓ Secure locking, thanks to access blocking

Push-in Technology 
Designed by PHOENIX CONTACT

 IO-Link

Product advantages at a glance



System transparency

Thanks to the comprehensive diagnostics capabilities, all process-related data is always available at a glance via the IO-Link interface. This provides you with a view of the nominal current, channel current and also the channel status of the device at all times, anywhere in the world. Simply connect the CBMC to the IO-Link master in your system to enable this function.



Worldwide device access

Once integrated in your system, you can configure and control the CBMC from anywhere in the world. Therefore, adjusting the nominal currents and switching the four independent channels remotely is no longer a problem. Adjustments can also be made at any time during operation.



Secure locking

Protect the device securely against unauthorized access. Either the complete device or just individual channels can be blocked via the IO-Link interface. This means local adjustments to the CBMC are impossible. Enjoy the highest level of protection with complete flexibility, thanks to the various locking options.



Service intervals

Manage rolling service intervals conveniently via the interface. Thanks to the internal memory, all device-specific data can be easily tracked. Read out the data and save it in a database. This enables service actions to be planned more efficiently and the costs arising from these are reduced enormously.



Convenient error diagnostics

CBMC circuit breakers detect various types of errors. Errors are recorded in the internal memory as soon as they occur. The IO-Link interface allows you unrestricted access to the error log. This simplifies troubleshooting in the event of an error and provides options for retroactive error diagnostics.



Autonomous operation

An IO-Link connection is not absolutely necessary to operate the device in the system. The device is fully functional without the IO-Link interface connection. This means you can preprogram the CBMC via the IO-Link interface and use it in the field autonomously.

Narrow electronic circuit breakers, universal at 6 mm

Ideally suited to simple, space-saving potential distribution: the PTCB single-channel electronic circuit breaker can be bridged to the CLIPLINE complete terminal block system and offers an adjustment range from 1 to 8 A, with a very narrow overall width.

i Web code: #1645

Push-in Technology [®]
Designed by PHOENIX CONTACT



Your advantages

- ✓ Simple application setup, thanks to the ability to bridge to the CLIPLINE complete terminal block system
- ✓ More space in the control cabinet: extremely narrow protection with a width of just 6 mm
- ✓ Flexible use and less inventory management due to adjustable current values on each device for a wide range of applications

Product advantages at a glance

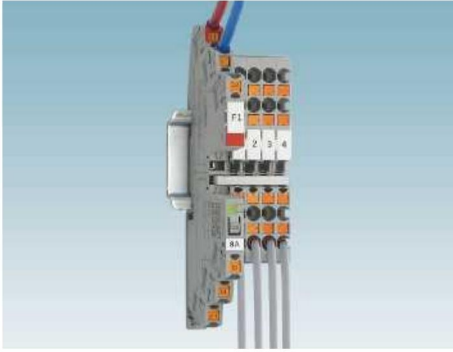

Simple application setup

The PTCB device circuit breaker can be bridged to the CLIPLINE complete terminal block system. You can use standard terminal blocks and accessories from the CLIPLINE complete system, and do not have to qualify any new materials. This enables you to quickly and easily add the ideal protection module to your existing applications.

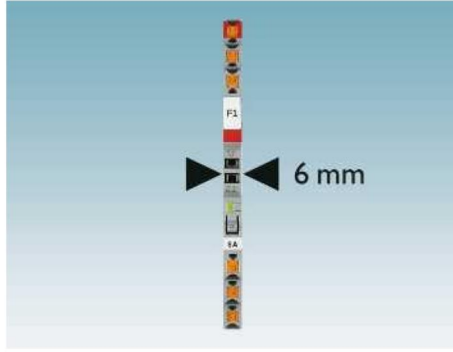

More space in the control cabinet

The PTCB enables potential distribution and device protection to be combined in a fast space-saving manner. With an overall width of just 6 mm, the PTCB reliably protects against overload and short-circuit currents. This enables you to achieve space savings of up to 70% compared to standard miniature circuit breakers. You benefit from reliable protection that takes up very little space.

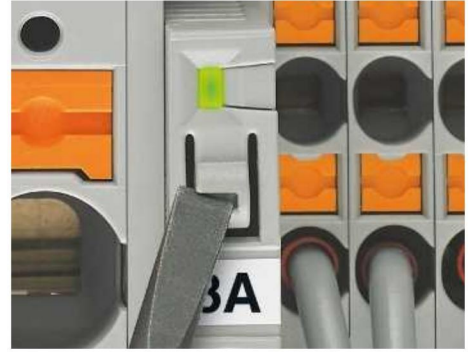

Flexible in use

With adjustable current values from 1 to 8 A, you can cover a wide range of applications. You can even make modifications during startup. You can respond to changes in the application at any time. Furthermore, you can reduce inventory and logistic costs with the flexible PTCB device circuit breaker for the widest range of applications.

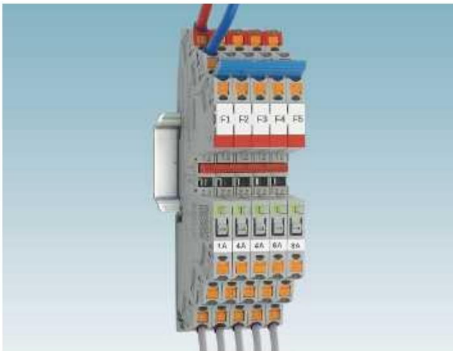

Individual setup

Anything is possible: the individually adjustable device circuit breaker offers unlimited possibilities. The number of channels you want to protect is irrelevant. Eliminate unnecessary channels, thereby reducing the costs of your system – with the flexible PTCB device circuit breaker for a wide variety of applications.



Transparent operating state

The LED indicates the operating state of the product and the connected devices. The status is visualized via traffic light colors. This unambiguous display allows you to intuitively understand the operating state and provides an at-a-glance overview. Thanks to the remote messaging function, you have the option of transmitting the status to a remote maintenance station.

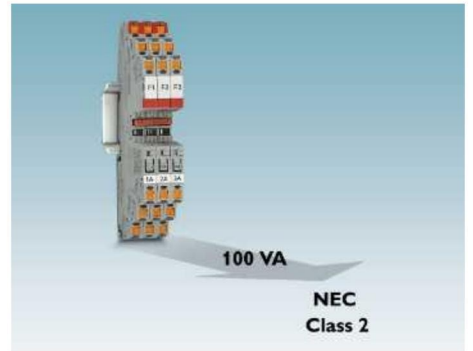

NEC Class 2 circuits

The device circuit breakers up to 3 A are approved in accordance with NEC Class 2. You can therefore easily configure energy-limited circuits with PTCB. Instead of an NEC Class 2 power supply unit, simply use your powerful standard power supply unit. Benefit from quicker and easier installation and testing of your application.

Individually customizable single-channel electronic circuit breakers

Build custom applications according to your requirements. The number of consumers you need to protect is irrelevant. Single-channel device circuit breakers can be expanded in a modular fashion and adapted to your particular situation.

i Web code: #1645

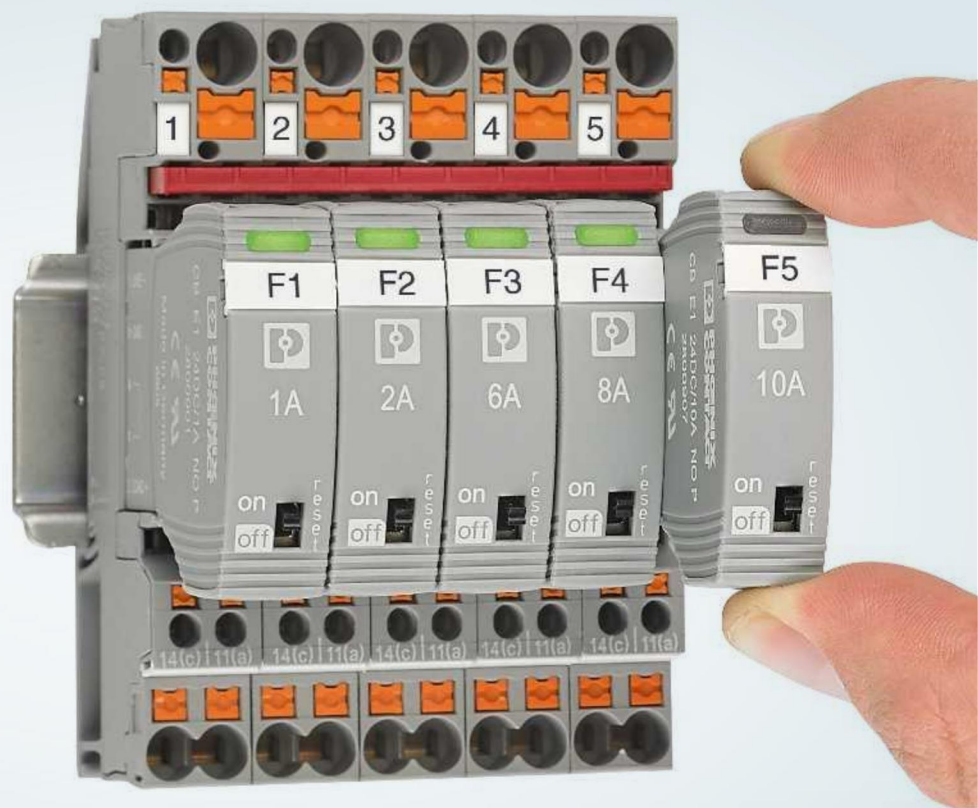

Your advantages

- ✓ Individually adjustable with protective plugs
- ✓ A large selection of protective plugs with fixed nominal current values for protection against unauthorized changes
- ✓ Active current limiting to improve the capacity of the upstream power supply

Product advantages at a glance



Individually adjustable

Pre-wire systems and control cabinets with base elements. Simply install the appropriate protective plug to suit your individual requirements at a later date. Should the demands placed on a consumer change in the meantime, you can simply replace the protective plug. The secure latching ensures the plug remains firmly in place, even in harsh environments.



Protection against changes

Increase the security of your system through fixed, unchangeable current values. This prevents unintentional adjustment of the channel currents. A large selection of protective plugs are available with the CB E circuit breakers. The nominal currents range from 1 to 10 A. Select the right protective plug for your area of application.

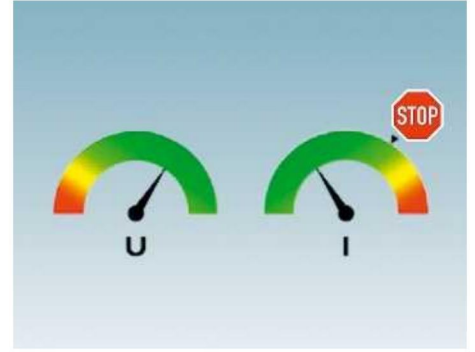

Active current limitation

The active current limitation restricts short circuit and overload currents to a value of 1.25 times the nominal current. This protects the power supply against excessively high currents and prevents output voltage dips at the switched-mode power supply unit. In addition, longer cable paths between the power supply and consumer are possible, without negatively impacting the shutdown behavior.



Remote control

The controller function of our CB E series does more than just provide you with the capability of switching different loads on and off remotely. Resetting a channel that has tripped is also possible. This eliminates the need for on-site maintenance if no ongoing fault has occurred.



Remote inspection

Increase the transparency of your system via our integrated remote messaging function. In the event of an error, you can obtain an overview of the problem – regardless of your location. This lets you find the faulty channel more quickly and therefore reduces the corresponding downtimes.

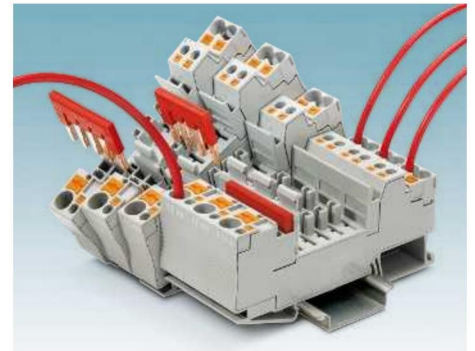

Quick and easy installation

The device circuit breakers can be easily combined using the unique bridging system from our standard range. Potentials of the same type can be connected quickly and safely. Thanks to the Push-in connection technology, you can wire the devices without tools. This saves time and costs during installation.

Individually customizable thermomagnetic device circuit breakers

Protect your application reliably against overload and short-circuit currents with the CB TM device circuit breakers. Thanks to the many different protective plugs, a large range is available for customizing your protection. Take advantage of the numerous features.

i Web code: #1647

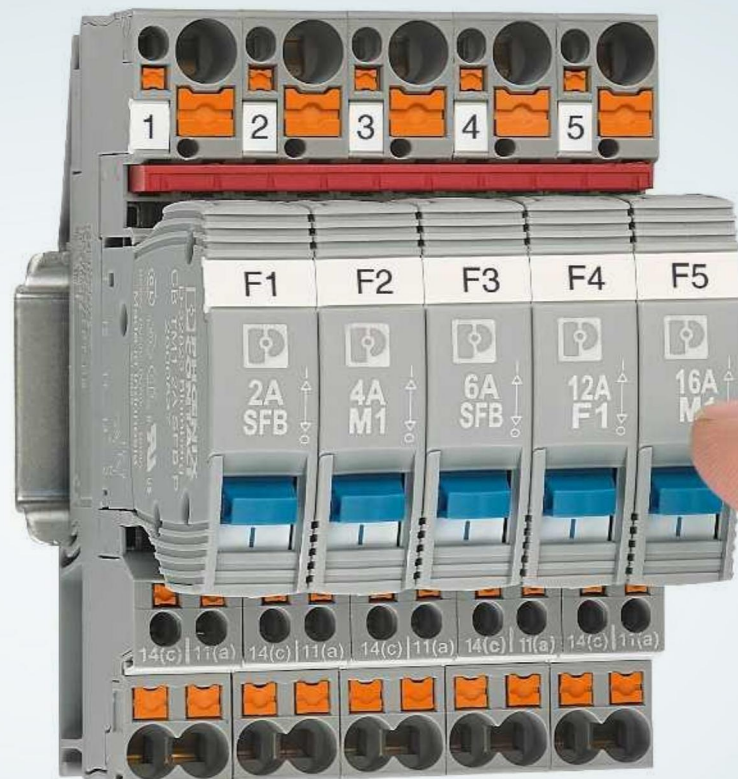

Your advantages

- ✓ Individually adjustable with protective plugs
- ✓ Easy characteristic curve selection: choose between three different characteristics
- ✓ A large selection of protective plugs with fixed nominal current values for protection against unauthorized changes

Product advantages at a glance



Individually adjustable

Pre-wire systems and control cabinets with base elements. Simply install the appropriate protective plug to suit your individual requirements at a later date. Should the demands placed on a consumer change in the meantime, you can simply replace the protective plug. The secure latching ensures the plug remains firmly in place, even in harsh environments.

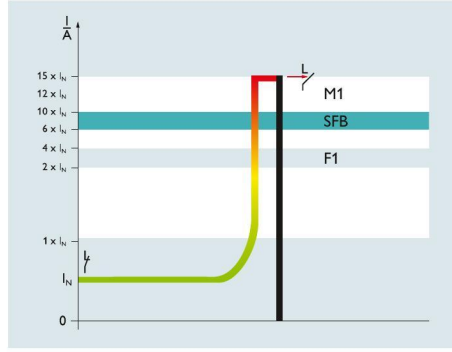

Simple characteristic curve selection

With the three different characteristic curve of the CB TM series, you always have the appropriate characteristic curve for your application. Select the F1 characteristic curve if you would like the tripping response to be as fast as possible. The M1 characteristic curve enables switching of higher starting currents. You can protect higher than average cable lengths via the SFB characteristic curve.

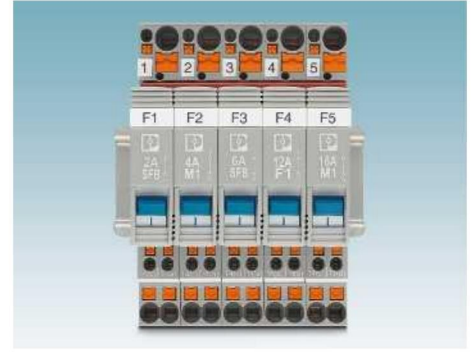

Large selection of current values

A large selection of protective plugs are available in the CB TM range. The nominal currents range from 0.5 to 16 A. Select the right protective plug for your area of application. Thanks to the fixed, unchangeable nominal currents of the plugs, you can increase the security of your system. This prevents unintentional changes to the channel currents.



Electrical isolation

Higher safety requirements exist in certain sectors of the industry. The electrical isolation of our thermomagnetic circuit breakers helps you comply with these requirements. This is because the power path is physically isolated in the event of an error. You therefore reliably protect your application against undesired currents.



1- and 2-pos. plugs

Ideal protection for your application. Plugs with various numbers of positions are available for this. Choose single-position plugs for the protection of grounded systems. Use our two-position plug to provide protection across all poles, as is required in insulated systems, for example. This way, you can ensure optimal protection for your system.

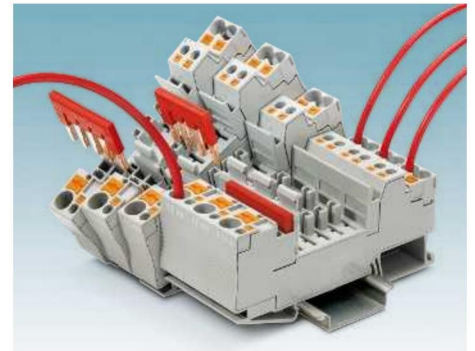

Quick and easy installation

The device circuit breakers can be easily combined using the unique bridging system from our standard range. Potentials of the same type can be connected quickly and safely. Thanks to the Push-in connection technology, you can wire the devices without tools. This saves time and costs during installation.

Thermomagnetic device circuit breakers with modular expansion capability

The UT 6-TMC device circuit breakers provide optimal basic protection. Thanks to their thermomagnetic characteristic curve, which is available in various nominal currents, they protect consumers and cables reliably against overload and short-circuit currents.

i Web code: #1647



Your advantages

- ✓ Simple feed-in, thanks to bridging capability using CLIPLINE complete accessories
- ✓ High system availability, thanks to easy resetting
- ✓ Quick and easy identification, thanks to large-area marking options

Product advantages at a glance



Simple feed-in

Feed-in to the UT 6-TMC is simple, thanks to the double bridge shaft. Systems can be quickly and easily expanded. You can use standard accessories from the CLIPLINE complete range, and do not need to qualify any new materials.



High system availability

Device replacement is not necessary in the event of an error. The system is easy to reset and can therefore be quickly brought back into operation. The trip-free mechanism prevents blocking of the shutdown.



Quick and easy identification

Each circuit can be clearly marked. The UT 6-TMC device circuit breaker features versatile and large-area marking options for this. This means the individual circuits can be quickly identified at a glance. This simplifies troubleshooting.

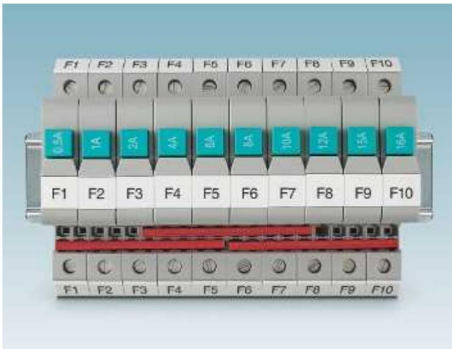

Large nominal current range

The device circuit breakers are available in 11 nominal current levels. With a nominal current range of 0.5 to 16 A, you are sure to find the appropriate device for your application.

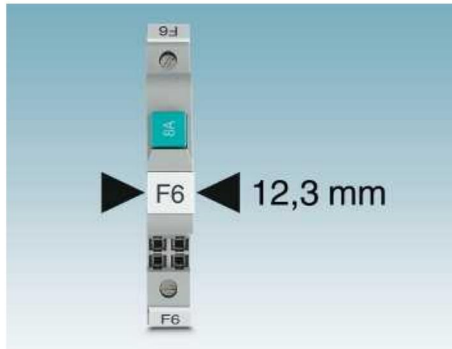

Compact design



The UT 6-TMC feature a narrow design, with a width of just 12.3 mm. Thanks to this compactness, you save 30% space in the control cabinet compared to standard miniature circuit breakers.



Connection technology

Take advantage of many years of experience in connection technology with the proven screw connection technology of the UT 6-TMC products.

Product and order overview





CBM: Multi-channel electronic circuit breakers		
 Web code: #1650		
Description	CBM with four channels	CBM with eight channels
Number of channels	4	8
Adjustable nominal current values	0.5/1/2/4/6/10 A	0.5/1/2/4/6/10 A
Preconfigured	Factory-set, 0.5 A	Factory-set, 0.5 A
Max. supply current	40 A	80 A
Backup fuse	15 A	15 A
Current limiting	•	•
Communication	Floating contact 13-14 Reset input (RST) Signal output I >80%	Floating contact 13-14 Reset input (RST) Signal output I >80%
Max. connection cross section (feed-in)	2 x 16 mm ²	2 x 16 mm ²
Dimensions (W x H x D)	41 mm x 130 mm x 121 mm	41 mm x 130 mm x 121 mm
Type	CBM E4 24DC/0.5 ... 10A NO-R	CBM E8 24DC/0.5 ... 10A NO-R
Order No.	2905743	2905744

CBM in use

The CBM saves a large amount of space, thanks to its narrow design. It protects various consumers in up to eight circuits. With current limitation, the risk in the event of an error is easily predictable. Thanks to its adjustability, the CBM can be adjusted to the system requirements, and protects sensors, actuators, relays, and much more.



CBMC: Compact multi-channel electronic circuit breakers





 Web code: #1651				
Description	CBMC 1-4 A	CBMC 1-10 A	CBMC 1-4 A with status and reset	CBMC 1-10 A with status and reset
Number of channels	4	4	4	4
Adjustable nominal current values	1 / 2 / 3 / 4 A	1 / 2 / 3 / 4 / 5 / 6 / 7 / 8 / 9 / 10 A	1 / 2 / 3 / 4 A	1 / 2 / 3 / 4 / 5 / 6 / 7 / 8 / 9 / 10 A
Preconfigured	Factory-set, 4 A	Factory-set, 4 A	Factory-set, 4 A	Factory-set, 4 A
Backup fuse	4 A	15 A	4 A	15 A
Communication	Floating contact 13-14	Floating contact 13-14	Status output (S) Reset input (RST)	Status output (S) Reset input (RST)
For NEC Class 2 circuits	•	–	•	–
Max. connection cross section (feed-in)	2 x 6 mm ²	2 x 6 mm ²	2 x 6 mm ²	2 x 6 mm ²
Dimensions (W x H x D)	36 mm x 90 mm x 98 mm	36 mm x 90 mm x 98 mm	36 mm x 90 mm x 98 mm	36 mm x 90 mm x 98 mm
Type	CBMC E4 24DC/1-4A NO	CBMC E4 24DC/1-10A NO	CBMC E4 24DC/1-4A S-R	CBMC E4 24DC/1-10A S-R
Order No.	2906031	2906032	1065727	1065729

CBMC in use

The multi-channel CBMC protects up to four circuits at the same time against the effects of overload and short-circuit currents. All devices are effectively protected, thanks to a combination of electronics and firmware. The four channels can be set individually from 1 to 10 A. A potential distribution can be optimally implemented to supply and protect several consumers. Thanks to its low height, the CBMC can be placed next to each terminal block, which saves space.





Product and order overview



CBMC: Compact multi-channel electronic circuit breakers, can be ordered preconfigured				
 Web code: #1651				
Description	CBMC 1-4 A	CBMC 1-10 A	CBMC 1-4 A with status and reset	CBMC 1-10 A with status and reset
Number of channels	4	4	4	4
Adjustable nominal current values	Can be ordered preconfigured Fixed from 1 to 4 A Or adjustable	Can be ordered preconfigured Fixed from 1 to 10 A Or adjustable	Can be ordered preconfigured Fixed from 1 to 4 A Or adjustable	Can be ordered preconfigured Fixed from 1 to 10 A Or adjustable
Backup fuse	4 A	15 A	4 A	15 A
Communication	Floating contact 13-14	Floating contact 13-14	Status output (S) Reset input (RST)	Status output (S) Reset input (RST)
For NEC Class 2 circuits	•	–	•	–
Max. connection cross section (feed-in)	2 x 6 mm ²	2 x 6 mm ²	2 x 6 mm ²	2 x 6 mm ²
Dimensions (W x H x D)	36 mm x 90 mm x 98 mm	36 mm x 90 mm x 98 mm	36 mm x 90 mm x 98 mm	36 mm x 90 mm x 98 mm
Type	CBMC E4 24DC/1-4A NO-C	CBMC E4 24DC/1-10A NO-C	CBMC E4 24DC/1-4A S-R-C	CBMC E4 24DC/1-10A S-R-C
Order No.	2908713*	2908716*	1103876*	1103875*

*Order No.	Adjustable	Ch. 1	Ch. 2	Ch. 3	Ch. 4	*Order No.	Adjustable	Ch. 1	Ch. 2	Ch. 3	Ch. 4
2908713	ADJ	1	3	1	4	2908716	ADJ	1	5	8	10
1103876	ADJ: adjustable FIX: not adjustable	Select the current value in amps individually for each channel 1 ... 4 A				1103875	ADJ: adjustable FIX: not adjustable	Select the current value in amps individually for each channel 1 ... 10 A			

CBMC: Compact multi-channel electronic circuit breakers with electrical isolation

 Web code: #1651	
Description	CBMC 1-8 A with electrical isolation
Number of channels	4
Adjustable nominal current values	1 / 2 / 3 / 4 / 5 / 6 / 7 / 8 A
Backup fuse	15 A
Communication	Floating contact 13-14
For NEC Class 2 circuits	-
Max. connection cross section (feed-in)	2 x 6 mm ²
Dimensions (W x H x D)	36 mm x 90 mm x 98 mm
Type	CBMC EG4 24DC/1-8A NO
Order No.	1065730

Product and order overview

CBMC IOL: Compact multi-channel electronic circuit breakers with IO-Link interface		
 Web code: #1652		
Description	CBMC 1-4 A nominal current with IO-Link interface	CBMC 1-10 A nominal current with IO-Link interface
Number of channels	4	4
Adjustable nominal current values	1 / 2 / 3 / 4 A	1 / 2 / 3 / 4 / 5 / 6 / 7 / 8 / 9 / 10 A
Preconfigured	Factory-set, 4 A	Factory-set, 4 A
Backup fuse	15 A	15 A
Communication	IO-Link interface	IO-Link interface
For NEC Class 2 circuits	•	–
Max. connection cross section (feed-in)	2 x 6 mm ²	2 x 6 mm ²
Dimensions (W x H x D)	36 mm x 90 mm x 98 mm	36 mm x 90 mm x 98 mm
Type	CBMC E4 24DC/1-4A+ IOL	CBMC E4 24DC/1-10A IOL
Order No.	2910410	2910411

CBMC with IO-Link application

The illustration shows a 24 V DC application with various sensors and actuators in combination with IO-Link. IO-Link is a manufacturer-independent standard. An extremely wide range of products transmit process-relevant data at the IO-Link level to the higher-level fieldbus via a master.

You can therefore maintain a clear overview of your system and stay informed about everything at all times. The currents can also be conveniently set remotely.

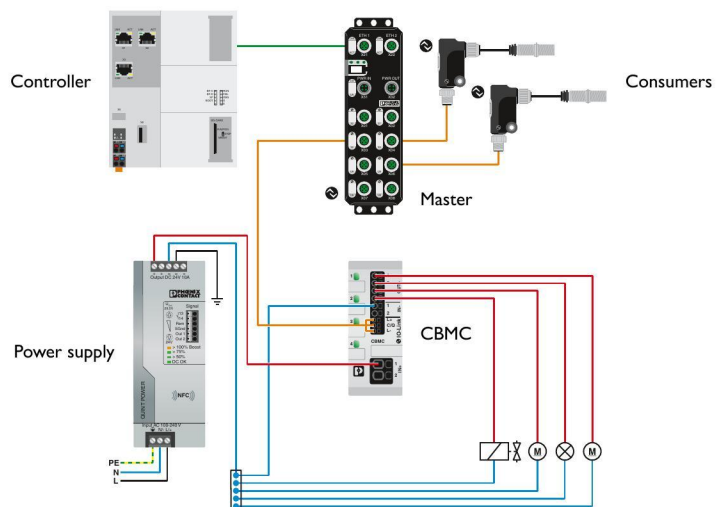

PTCB: Narrow electronic circuit breakers, adjustable





 Web code: #1649			
Description	PTCB 1-3 A	PTCB 1-4 A	PTCB 1-8 A
Adjustable nominal current values	1 / 2 / 3 A	1 / 2 / 3 / 4 A	1 / 2 / 3 / 4 / 5 / 6 / 7 / 8 A
Preconfigured	Factory-set, 3 A	Factory-set, 4 A	Factory-set, 4 A
Backup fuse	4 A	4 A	15 A
Communication	Floating contact 13-14	Floating contact 13-14	Floating contact 13-14
Operating voltage	18 V DC ... 27.5 V DC	18 V DC ... 30 V DC	18 V DC ... 30 V DC
For NEC Class 2 circuits	•	–	–
Dimensions (W x H x D)	6.2 x 105.8 x 55.6 mm	6.2 x 105.8 x 55.6 mm	6.2 x 105.8 x 55.6 mm
Type	PTCB E1 24DC/1-3A NO	PTCB E1 24DC/1-4A NO	PTCB E1 24DC/1-8A NO
Order No.	2909909	2908261	2908262



PTCB in use

The very narrow electronic PTCBs can be optimally adjusted to the number of loads requiring protection. They have a comprehensive range of bridging options for the input and output potentials. This allows the protection to be adapted to the respective application with little wiring effort. Individual protection of the loads and potential distribution across several loads can be set up quickly and easily.



Product and order overview

PTCB: Narrow electronic circuit breakers with fixed nominal currents				
 Web code: #1649				
Description	PTCB 1 A	PTCB 2 A	PTCB 3 A	PTCB 4 A
Nominal current values	1 A	2 A	3 A	4 A
Backup fuse	4 A	4 A	4 A	4 A
Communication	Floating contact 13-14	Floating contact 13-14	Floating contact 13-14	Floating contact 13-14
Operating voltage	18 V DC ... 30 V DC	18 V DC ... 30 V DC	18 V DC ... 27.5 V DC	18 V DC ... 30 V DC
For NEC Class 2 circuits	•	•	•	–
Dimensions (W x H x D)	6.2 mm x 105.8 mm x 55.6 mm	6.2 mm x 105.8 mm x 55.6 mm	6.2 mm x 105.8 mm x 55.6 mm	6.2 mm x 105.8 mm x 55.6 mm
Type	PTCB E1 24DC/1A NO	PTCB E1 24DC/2A NO	PTCB E1 24DC/3A NO	PTCB E1 24DC/4A NO
Order No.	2909902	2909903	2909904	2909906

PTCB: Narrow electronic circuit breakers with fixed nominal currents		
 Web code: #1649		
Description	PTCB 6 A	PTCB 8 A
Nominal current values	6 A	8 A
Backup fuse	15 A	15 A
Communication	Floating contact 13-14	Floating contact 13-14
Operating voltage	18 V DC ... 30 V DC	18 V DC ... 30 V DC
For NEC Class 2 circuits	–	–
Dimensions (W x H x D)	6.2 mm x 105.8 mm x 55.6 mm	6.2 mm x 105.8 mm x 55.6 mm
Type	PTCB E1 24DC/6A NO	PTCB E1 24DC/8A NO
Order No.	2909908	2909910

PTCB accessories for a variety of applications

Feed-in directly at PTCB distributed between terminal blocks

	Type	Order No.
	PT 4-QUATTRO	3211797
	D-ST 4-QUATTRO	3208979
	Plug-in bridge	
	FBS 5-6 GY	3032266

Feed-in directly at PTCB

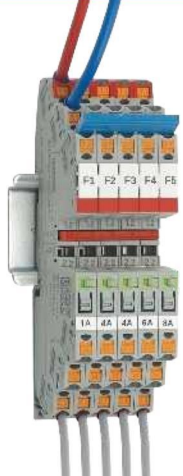
	Type	Order No.
	Plug-in bridges	
	FBS 5-6	3030349
	FBS 5-6 BU	3036961
	Set of 50 wire bridges	
	DB 50- 90 BK	2820916
	DB 50- 90 BU	2821180
	DB 50- 90 RD	2864639
	DB 50- 90 GY	2820929

Feed-in with large cross-section

	Type	Order No.
	PT 10	3212120
	D-PT 10	3212057
	PT 4-QUATTRO	3211797
	D-ST 4-QUATTRO	3208979
	Plug-in bridges	
	RB ST 10-(2,5/4)	3030873
FBS 5-6 GY	3032266	

Product and order overview

CB E: Electronic circuit breakers

i Web code: #1648

Base element:
Push-in connection 2800929
Screw connection 2801305



Description	N/O contact (NO)	N/C contact (NC)	Status output and reset input (S-R)	Status output and control input (S-C)
Nominal voltage	24 V DC	24 V DC	24 V DC	24 V DC
Nominal current 1 A	CB E1 24DC/1A NO P Order number 2800901	CB E1 24DC/1A NC P Order number 2800915	CB E1 24DC/1A S-R P Order number 2800908	CB E1 24DC/1A S-C P Order number 2800922
Nominal current 2 A	CB E1 24DC/2A NO P Order number 2800902	CB E1 24DC/2A NC P Order number 2800916	CB E1 24DC/2A S-R P Order number 2800909	CB E1 24DC/2A S-C P Order number 2800923
Nominal current 3 A	CB E1 24DC/3A NO P Order number 2800903	CB E1 24DC/3A NC P Order number 2800917	CB E1 24DC/3A S-R P Order number 2800910	CB E1 24DC/3A S-C P Order number 2800924
Nominal current 4 A	CB E1 24DC/4A NO P Order number 2800904	CB E1 24DC/4A NC P Order number 2800918	CB E1 24DC/4A S-R P Order number 2800911	CB E1 24DC/4A S-C P Order number 2800925
Nominal current 6 A	CB E1 24DC/6A NO P Order number 2800905	CB E1 24DC/6A NC P Order number 2800919	CB E1 24DC/6A S-R P Order number 2800912	CB E1 24DC/6A S-C P Order number 2800926
Nominal current 8 A	CB E1 24DC/8A NO P Order number 2800906	–	CB E1 24DC/8A S-R P Order number 2800913	CB E1 24DC/8A S-C P Order number 2800927
Nominal current 10 A	CB E1 24DC/10A NO P Order number 2800907	–	CB E1 24DC/10A S-R P Order number 2800914	CB E1 24DC/10A S-C P Order number 2800928

CB E in use

The CB E circuit breakers have a modular design which means the protection can be perfectly adjusted. The system is ideally protected, thanks to the fixed current values which effectively prevent manipulation of the current intensities. One advantage of electronic circuit breakers is that the current reserve is more likely to be sufficient in the event of an emergency. The system availability is effectively increased.



UT 6-TMC: Thermomagnetic device circuit breakers

i Web code: #1655



Description	TMC device circuit-breaker
Nominal current 0.5 A	UT 6-TMC M 0.5A Order number 0916603
Nominal current 1 A	UT 6-TMC M 1A Order number 0916604
Nominal current 2 A	UT 6-TMC M 2A Order number 0916605
Nominal current 4 A	UT 6-TMC M 4A Order number 0916606
Nominal current 5 A	UT 6-TMC M 5A Order number 0916607
Nominal current 6 A	UT 6-TMC M 6A Order number 0916608
Nominal current 8 A	UT 6-TMC M 8A Order number 0916609
Nominal current 10 A	UT 6-TMC M 10A Order number 0916610
Nominal current 12 A	UT 6-TMC M 12A Order number 0916611
Nominal current 15 A	UT 6-TMC M 15A Order No.: 0916612
Nominal current 16 A	UT 6-TMC M 16A Order number 0916613

UT 6-TMC in use

Thanks to the single-channel design of the UT 6-TMC, a configuration in which consumers are selectively protected can be quickly and easily established. The generously-sized marking area helps with identification in the event of errors. Fast recommissioning is possible, as the products can be reset.



Product and order overview

CB-TM: Thermomagnetic device circuit breakers, 1-pos.

i Web code: #1653

Base element: Push-in connection 2800929
Screw connection 2801305



Characteristic curve	SFB	M1	F1
Remote signaling function	1 changeover contact	1 changeover contact	1 changeover contact
Number of positions	1	1	1
Nominal current 0.5 A	CB TM1 0.5A SFB P Order number 2800835	CB TM1 0.5A M1 P Order number 2800846	CB TM1 0.5A F1 P Order number 2800857
Nominal current 1 A	CB TM1 1A SFB P Order number 2800836	CB TM1 1A M1 P Order number 2800847	CB TM1 1A F1 P Order number 2800858
Nominal current 2 A	CB TM1 2A SFB P Order number 2800837	CB TM1 2A M1 P Order number 2800848	CB TM1 2A F1 P Order number 2800859
Nominal current 3 A	CB TM1 3A SFB P Order number 2800838	CB TM1 3A M1 P Order number 2800849	CB TM1 3A F1 P Order number 2800860
Nominal current 4 A	CB TM1 4A SFB P Order number 2800839	CB TM1 4A M1 P Order number 2800850	CB TM1 4A F1 P Order number 2800861
Nominal current 5 A	CB TM1 5A SFB P Order number 2800840	CB TM1 5A M1 P Order number 2800851	CB TM1 5A F1 P Order number 2800862
Nominal current 6 A	CB TM1 6A SFB P Order number 2800841	CB TM1 6A M1 P Order number 2800852	CB TM1 6A F1 P Order number 2800863
Nominal current 8 A	CB TM1 8A SFB P Order number 2800842	CB TM1 8A M1 P Order number 2800853	CB TM1 8A F1 P Order number 2800864
Nominal current 10 A	CB TM1 10A SFB P Order number 2800843	CB TM1 10A M1 P Order number 2800854	CB TM1 10A F1 P Order number 2800865
Nominal current 12 A	CB TM1 12A SFB P Order number 2800844	CB TM1 12A M1 P Order number 2800855	CB TM1 12A F1 P Order number 2800866
Nominal current 16 A	CB TM1 16A SFB P Order number 2800845	CB TM1 16A M1 P Order number 2800856	CB TM1 16A F1 P Order number 2800867

CB TM in use

In addition to the modular design, the CB TM... circuit breakers feature electrical isolation. In the event of an error, the relevant circuit is isolated safely and physically. The circuit can only be recommissioned once it has been connected manually. The various characteristic curves provide ideal protection.



CB-TM: Thermomagnetic device circuit breakers, 2-pos.

<p>i Web code: #1654</p> <p>Base element: Push-in connection 2800929 Screw connection 2801305</p>			
Characteristic curve	SFB	M1	F1
Remote signaling function	2 changeover contacts	2 changeover contacts	2 changeover contacts
Number of positions	2	2	2
Nominal current 0.5 A	CB TM2 0.5A SFB P Order number 2800868	CB TM2 0.5A M1 P Order number 2800879	CB TM2 0.5A F1 P Order number 2800890
Nominal current 1 A	CB TM2 1A SFB P Order number 2800869	CB TM2 1A M1 P Order number 2800880	CB TM2 1A F1 P Order number 2800891
Nominal current 2 A	CB TM2 2A SFB P Order number 2800870	CB TM2 2A M1 P Order number 2800881	CB TM2 2A F1 P Order number 2800892
Nominal current 3 A	CB TM2 3A SFB P Order number 2800871	CB TM2 3A M1 P Order number 2800882	CB TM2 3A F1 P Order number 2800893
Nominal current 4 A	CB TM2 4A SFB P Order number 2800872	CB TM2 4A M1 P Order number 2800883	CB TM2 4A F1 P Order number 2800894
Nominal current 5 A	CB TM2 5A SFB P Order number 2800873	CB TM2 5A M1 P Order number 2800884	CB TM2 5A F1 P Order number 2800895
Nominal current 6 A	CB TM2 6A SFB P Order number 2800874	CB TM2 6A M1 P Order number 2800885	CB TM2 6A F1 P Order number 2800896
Nominal current 8 A	CB TM2 8A SFB P Order number 2800875	CB TM2 8A M1 P Order number 2800886	CB TM2 8A F1 P Order number 2800897
Nominal current 10 A	CB TM2 10A SFB P Order number 2800876	CB TM2 10A M1 P Order number 2800887	CB TM2 10A F1 P Order number 2800898
Nominal current 12 A	CB TM2 12A SFB P Order number 2800877	CB TM2 12A M1 P Order number 2800888	CB TM2 12A F1 P Order number 2800899
Nominal current 16 A	CB TM2 16A SFB P Order number 2800878	CB TM2 16A M1 P Order number 2800889	CB TM2 16A F1 P Order number 2800900

Power supplies and device circuit breakers

When using electronic circuit breakers, a low current reserve is already sufficient for safe, reliable protection. The boost function of our TRIO POWER and QUINT POWER power supplies provides this current reserve, even with 100% capacity utilization. This is an easy way to ensure high system availability.

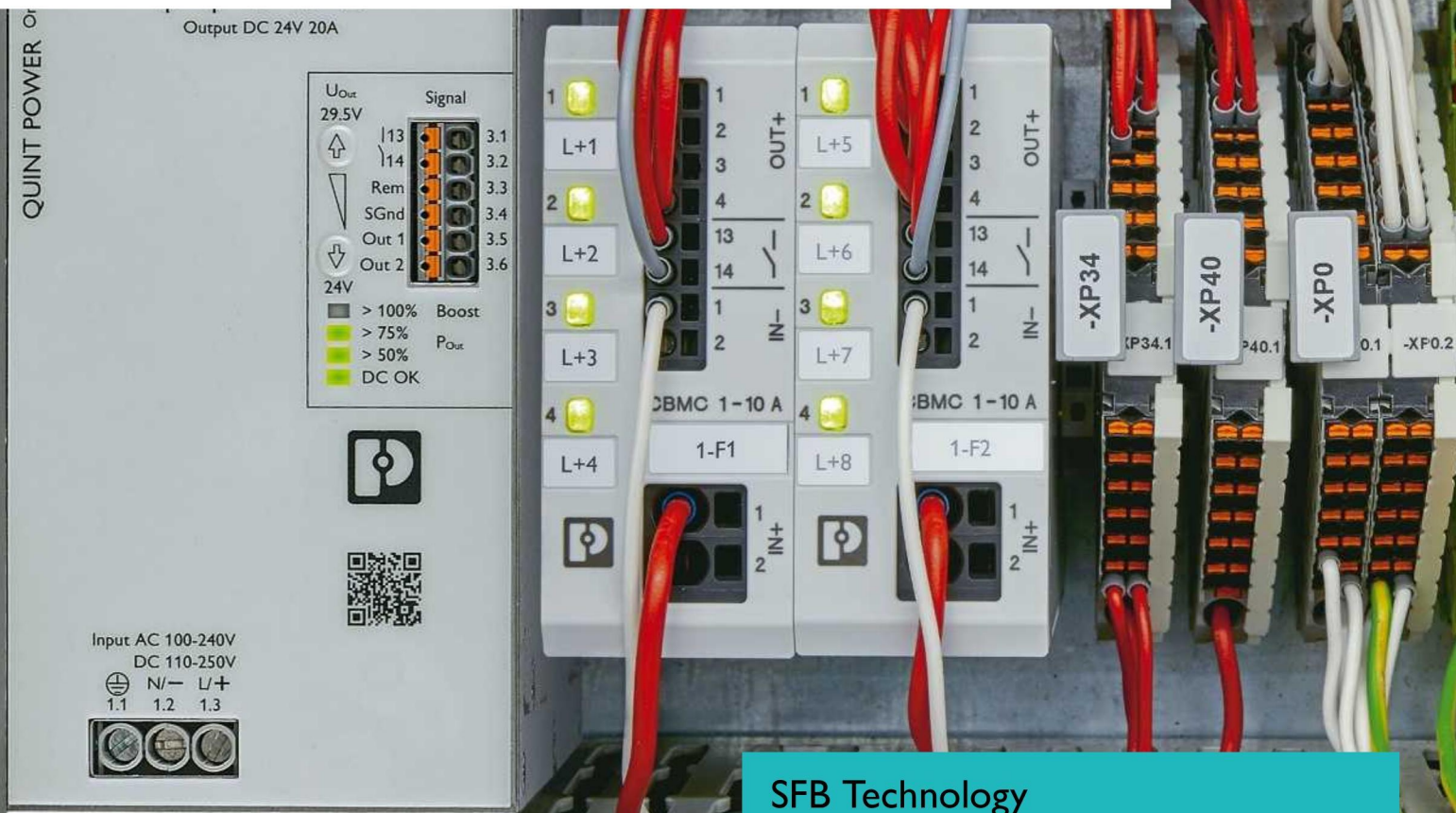

SFB Technology

A multiple of the nominal current is required briefly in order to ensure thermomagnetic device circuit breakers are tripped securely. The SFB Technology of the QUINT POWER power supply is particularly well suited for this. It supplies up to six times the nominal current for 15 ms.

Designed by PHOENIX CONTACT

PHOENIX CONTACT

RSPSupply - 1-888-532-2706 - <https://www.RSPSupply.com>
See the product details here



The best combination for superior system availability

TRIO POWER: Robust power supplies

TRIO POWER power supplies are ideal for use in machine building. All functions and the space-saving design are tailored to the stringent demands in this area.

The power supply units, which feature an extremely robust electrical and mechanical design, ensure a reliable supply to all consumers, even under harsh ambient conditions.

- Highly cost-effective, thanks to time-saving, tool-free Push-in connection
- Reliable starting of heavy loads, dynamic power reserve 150% (max. 5 s)

- Electrically robust, thanks to high electric strength
- Mechanically robust, thanks to high vibration and shock resistance



QUINT POWER: High-performance power supplies

QUINT POWER power supplies contain new functions which ensure superior system availability. SFB technology and preventive function monitoring increase the availability of your application.

Signaling thresholds and characteristic curves can be individually adjusted. Furthermore, they can be ordered preconfigured from a batch quantity of just 1.

- System can be easily expanded, thanks to static boost with permanent 125% performance
- Reliable starting of heavy loads, thanks to dynamic boost with up to 200% power for 5 s

- High level of immunity, thanks to integrated gas discharge tube, more than 20 ms mains buffering
- Comprehensive signaling
- Preventive function monitoring highlights critical operating states before errors occur



The right protection for your requirements

	Electronic circuit breakers		Thermomagnetic device circuit breakers	
	CBM, CBMC, PTCB, CB E		CB TM Adapted char. curves SFB, F1, M1	UT 6-TMC Med. time-lag char. curves M1
<ul style="list-style-type: none"> Overload and short circuit Overload SFB not necessary 				
Power supply	CBM, CBMC, PTCB, CB E		CB TM Adapted char. curves SFB, F1, M1	UT 6-TMC Med. time-lag char. curves M1
TRIO POWER Boost				
QUINT POWER Boost				
QUINT POWER SFB Technology				

Open communication with customers and partners worldwide

Phoenix Contact is a global market leader based in Germany. We are known for producing future-oriented components, systems, and solutions in the fields of electrical engineering, electronics, and automation. With a global network reaching across more than 100 countries with over 17,400 employees, we maintain close relationships with our customers, something we believe is essential for success.

Our wide variety of innovative products makes it easy for our customers to implement the latest technology in a variety of applications and industries. We focus on developing the fields of energy, infrastructure, process, and factory automation.

You can find our complete product range at:
phoenixcontact.com



PHOENIX CONTACT GmbH & Co. KG
Flachmarktstraße 8
32825 Blomberg, Germany
Phone: +49 52 35 3-00
Fax: +49 52 35 3-4 12 00
E-mail: info@phoenixcontact.com
phoenixcontact.com

INSPIRING INNOVATIONS